

Specification Sheet

Model #: PC36x24x36REC

36" L x 24" W x 36" tall Classic Series concrete planter

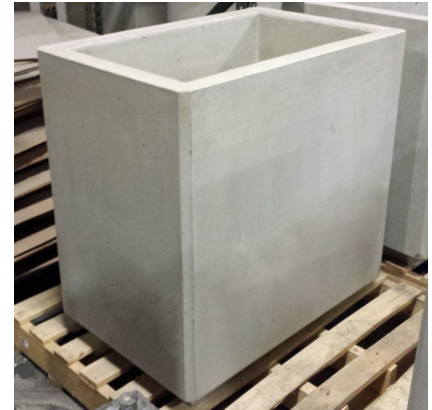
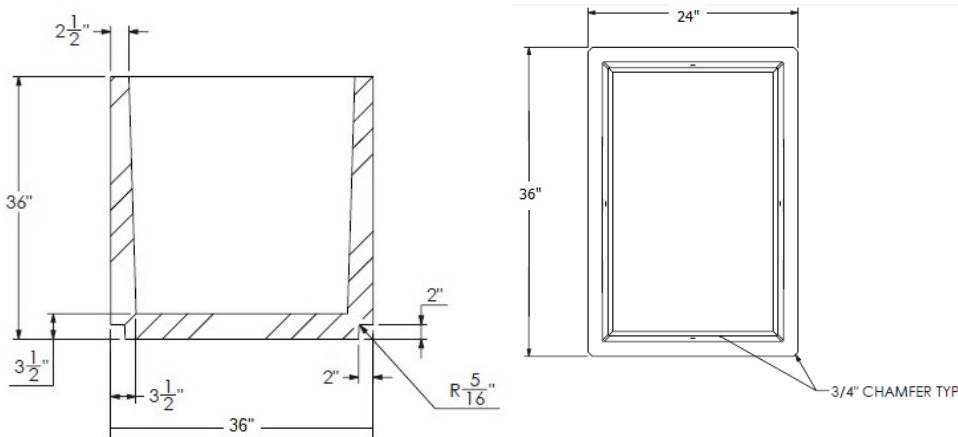

*Shown in Natural concrete color and finish.

Specifications:

- **Dimensions:** 36" L x 24" W x 36" tall with 2" tall x 2" deep toe kick at base.
- **Weight:** 1285lbs
- **Materials:** 3/8" steel rebar, Type III Portland cement conforming to ASTM C150. All aggregate conforming to ASTM C33. All Steel Rebar conforming to ASTM – A 615. Due to the natural air entraining properties of Portland Type III cement, additional air entraining agents are not required. Air void content naturally occurring in a Type III Portland Cement mixture conforms to ASTM C457.
- **Stress Load:** Minimum 5000 PSI at 28 days
- **Color & Finish Options:** Please reference standard color/finish sheet.
- **Warranty:** One year warranty against manufacturer's defects.