

DAWN

Enterprises

Specification Sheet AS36S: 36" Square Stone Aggregate Ashtray

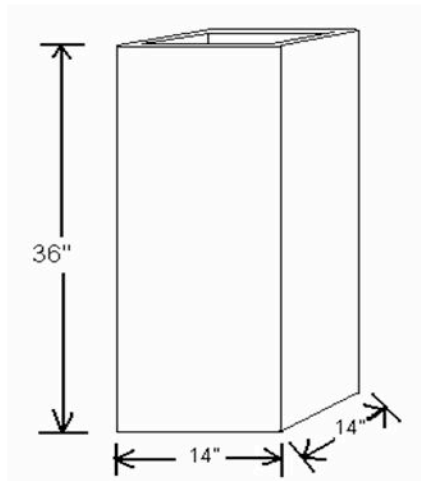

Specifications:

- Dimensions: 14" x 14" x 36"
- Weight: 180lbs
- Materials: Natural 3/8" river stone aggregate
- Color Options: Natural Brown, Brick Red, Grey, Black, or custom
- Other Options: Custom and standard logos also available
- Warranty: One year warranty against manufacturer's defects